

Food Image Recognition Using Deep Convolutional Network with Pre-training and Fine-tuning



ICME Workshop on Multimedia
for Cooking and Eating Activities (CEA)

July 3th 2015

Keiji Yanai and Yoshiyuki Kawano

The Univ. of Electro-Communications, Tokyo, Japan

Introduction: Food & Deep

- **Food image recognition :**
 - One of important topics in CEA community
 - Helpful for food habit recording.
- **Deep Convolutional Neural Network:**
 - Best image classification method at present
 - ILSVRC, Pascal VOC, MIT-SUN, Caltech-101/256,...



How about food datasets such as
UEC-Food101/256 and ETH Food-101 ?

<http://foodcam.mobi/>

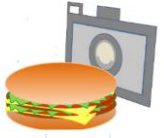

FoodCam : [Kawano et al. MTA13]

- Real-time mobile food recognition
Android application



Objectives of this work

- **[Experiments]**

- Introduce deep convolutional neural networks (DCNN) into food image classification task

- Examine its effectiveness

- **[Application]**

- Apply DCNN-based food classifier to Twitter food photo mining .

Deep Convolutional Neural Network (DCNN)

- The most common network architecture for image classification: **AlexNET** proposed by Alex Krizhevsky in ILSVRC2012.

Alex Krizhevsky, I.Sutskever, J. Hinton : ImageNet Classification with Deep Convolutional Neural Networks, NIPS 2012.

➔ We use this in this work.

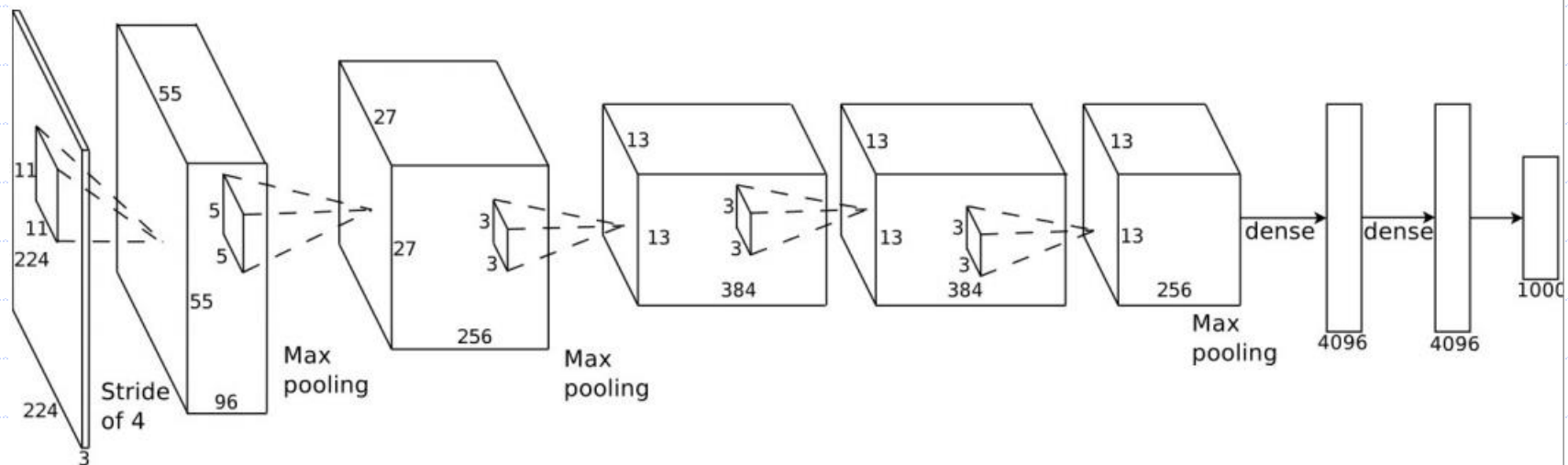

Deep Convolutional Neural Network

- Consists of convolutional layers and full connection layers.

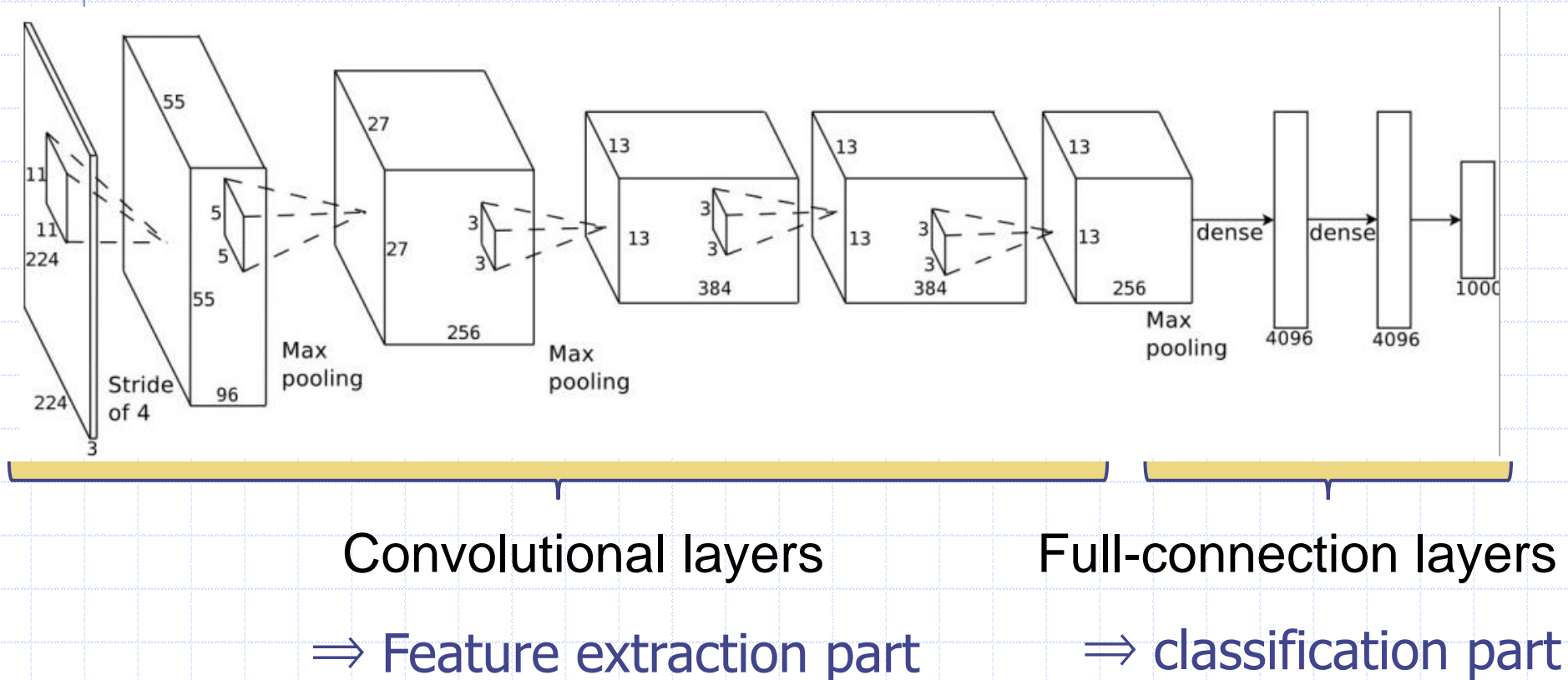

Most activated location on 3rd conv. layer

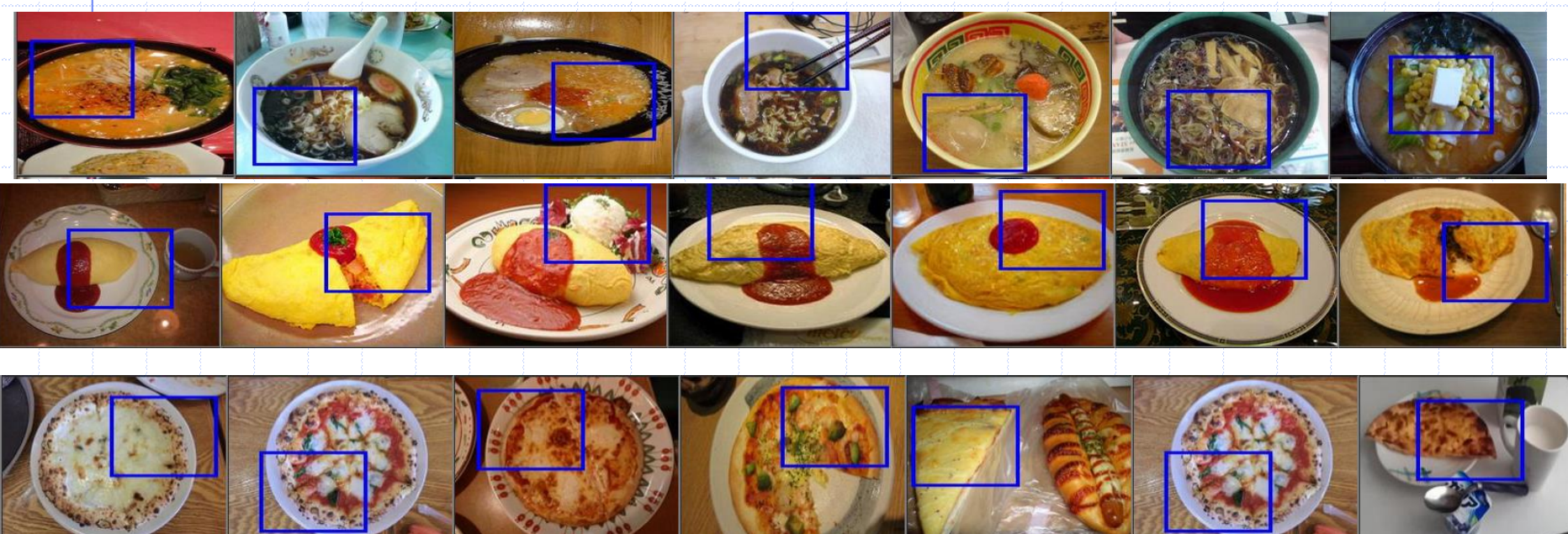
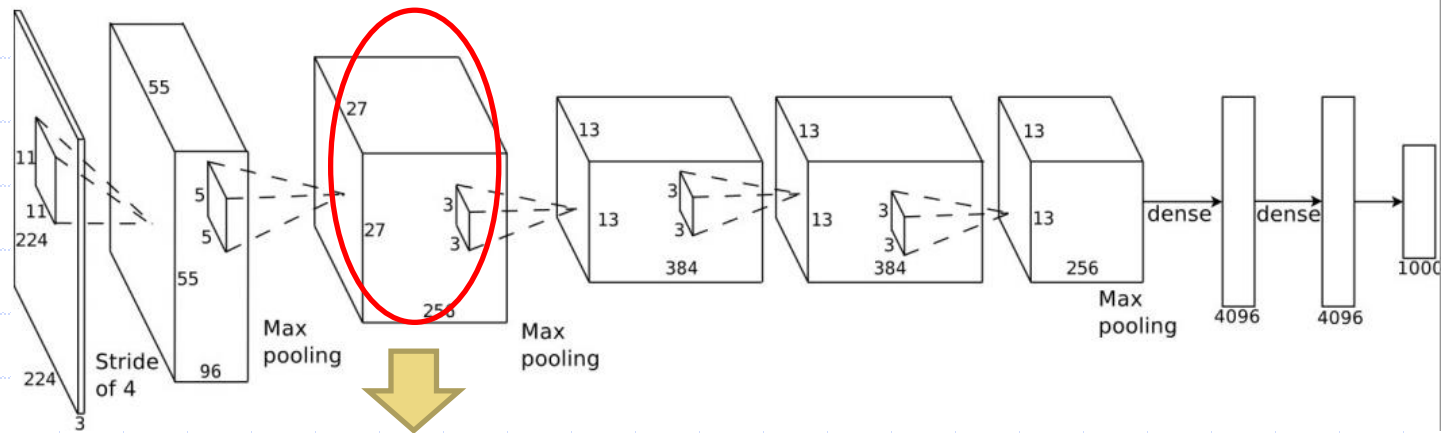

[Existing works]

DCNN with Food Dataset

- [Kawano et al. CEA2014]
 - DCNN activation features
(**pre-trained with ILSVRC data**)
 - UEC-FOOD100: FV: 65.32%
 - DCNN 57.87%, DCNN+FV: **72.26%** (**best so far**)
- Other work:
 - [Kagaya et al. MM2014] 10 kinds of foods with DCNN trained **from scratch**
 - [Bossard et al. ECCV2014] ETH-Food101 with AlexNet **from scratch**

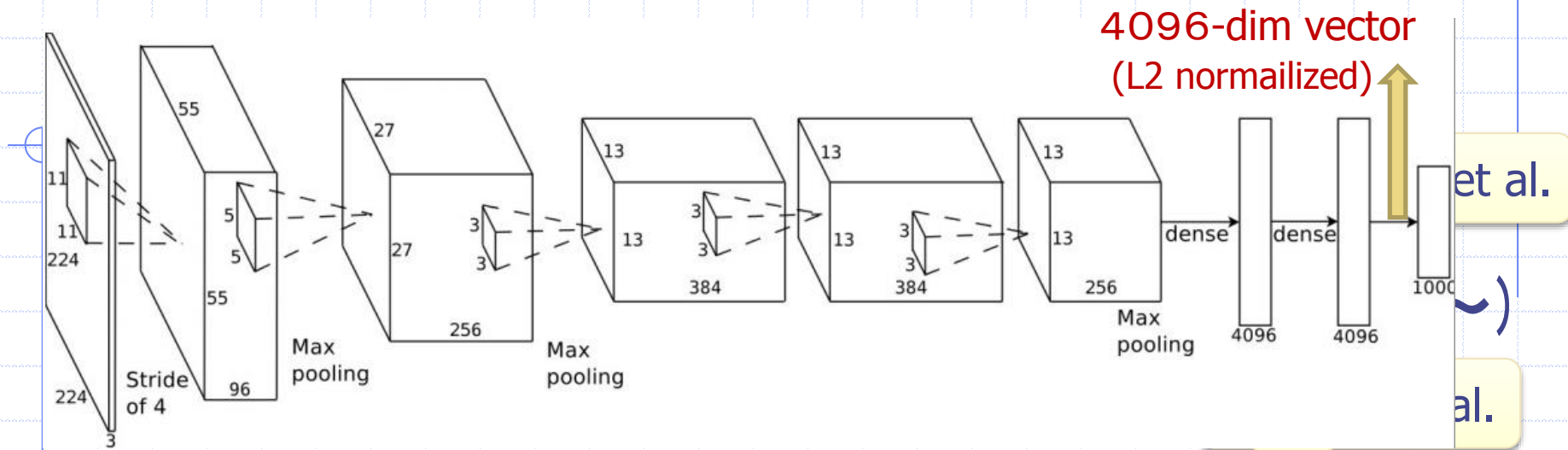

2. Use activation features of pre-trained DCNN

- Extract activation signals from the previous layer of the last one, and use them as visual features
- Easiest among three. (by using Caffe or Overfeat)

3. Fine-tune a pre-trained DCNN using non-large-scale dataset

Not explored yet

- Even small data can improve performance over (2)

Introducing pre-training with non-ILSVRC and Fine-tuning

- Existing works: training from scratch or using pre-trained model with ILSVRC

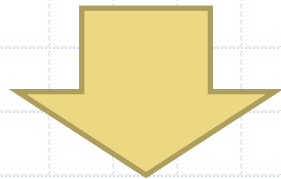

Two kinds of extensions

- Pre-training with food-related ImageNet categories
- Fine-tuning

DCNN pre-training Datasets

- ILSVRC2012
 - Large Scale Visual Recognition Challenge
 - one thousand training images per category
 - Generic 1000 categories
 - few food categories

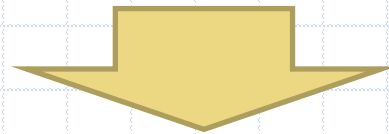

DCNN pre-trained with the dataset containing more food-related categories is desirable.

DCNN pre-training Datasets containing more foods

- Select 1000 food-related categories from ImageNet
 - List up all the word under “food” in the ImageNet hierarchy
 - 1526 synsets related to “food”
 - Exclude synsets included in ILSVRC dataset
 - Select the top 1000 synsets in terms of # of images in ImageNet

* ImageNet 2011 Fall release

DCNN pre-training Datasets

- ImageNet2000 categories
 - 1000 food-related categories from ImageNet
 - ImageNet1000 (ILSVRC) categories
- = 2000 categories

Pre-training with ImageNet2000

- DCNN Features with ImageNet 2000 categories
 - Using Caffe
 - The dimension of full connection layers is modified from 4096 to 6144, since the output dimension is raised from 1000 to 2000.
- Training time
 - About one week (training from scratch)
 - GPU, Nvidia Geforce TITAN BLACK, 6GB

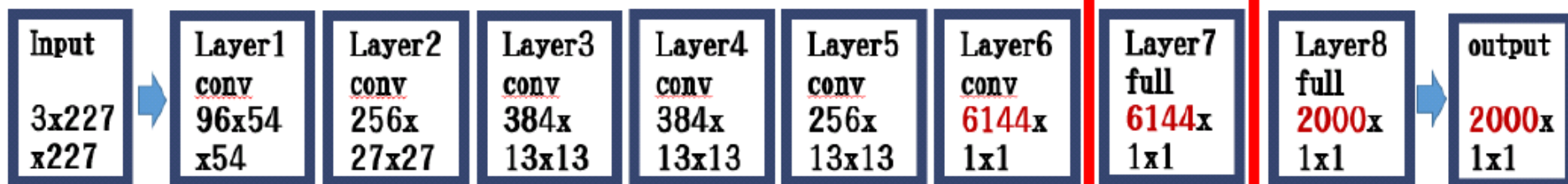

Fine-tuning with small dataset

- Modify the size of the last layer (2000 \Rightarrow 100)
- Re-train only weight parameters of full connection layers (L6,7,8)
- Weights from L1-5 are fixed

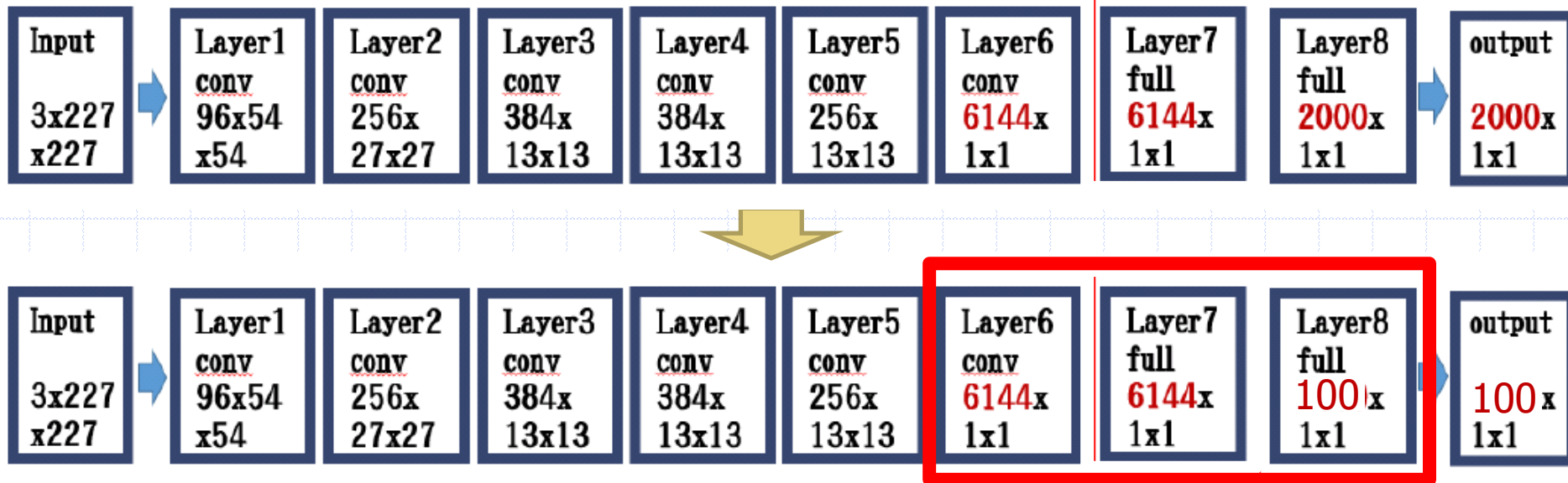

Fine-tuning

- It enables DCNN to be trained with small data.
- Feature extraction parts are trained with large-scale data such as ImageNet.
- Classification parts are trained with small-scale target data.

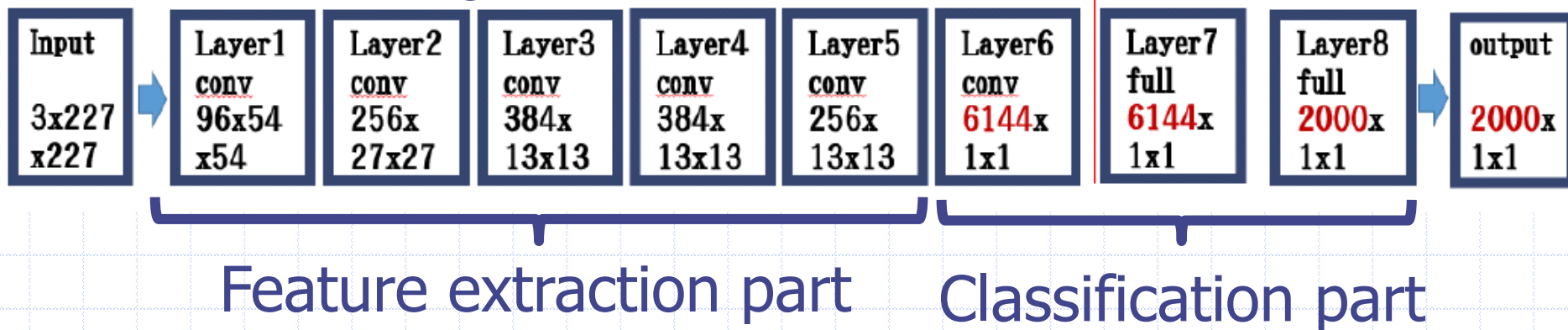

Experiments: Food dataset

- **UEC-FOOD100/256 dataset**
 - 100 / 256 food categories (Japanese and Asian)
 - More than 100 images for each category
 - Bounding box information for all the images
- **ETH Food-101 [Bossard et al. ECCV2014]**
 - 101 categories, 1000 images for each category (mainly western and partly Japanese)
 - Collecting from <http://www.foodspotting.com/>
 - 20 categories are overlapped with UEC-FOOD100

UEC-FOOD 100

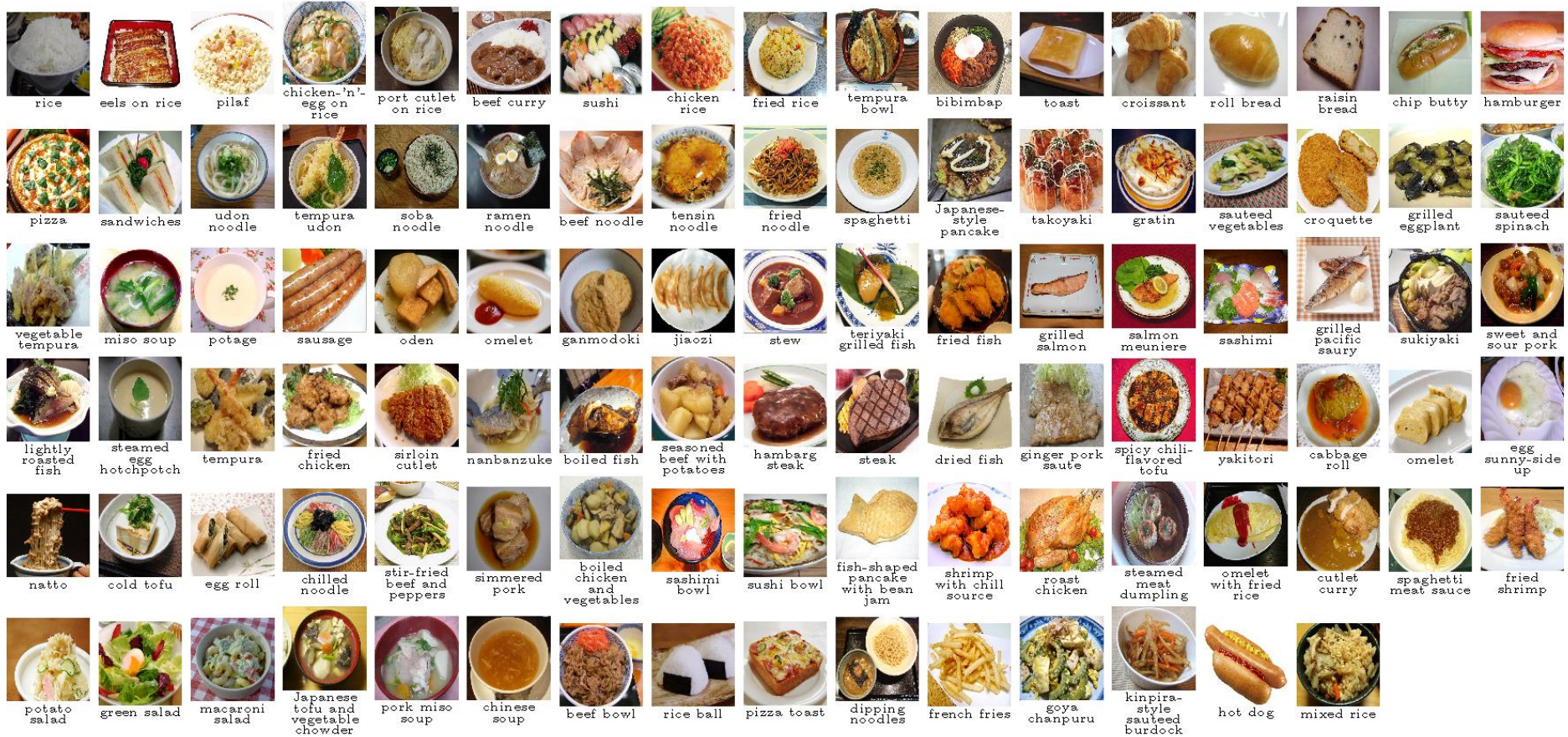

UEC-FOOD 100

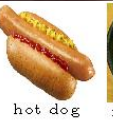

UEC-FOOD 100



UEC-FOOD 100



UEC-FOOD 100

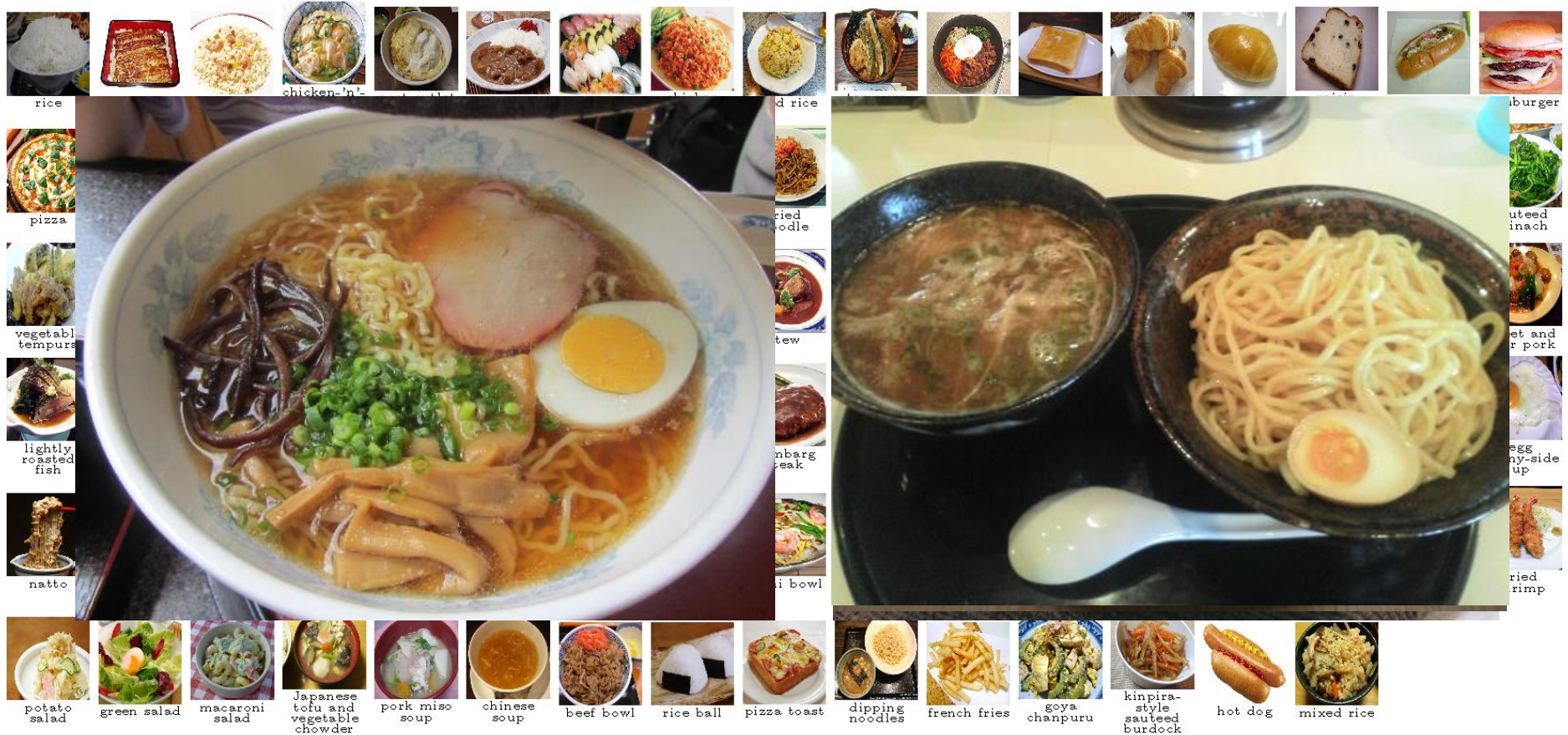

rice chicken-pizza fried rice

pizza fried noodle

vegetabl tempura stew

lightly roasted fish pork steak

natto chili bowl

potato salad green salad macaroni salad Japanese tofu and vegetable chowder pork miso soup chinese soup beef bowl rice ball pizza toast

dipping noodles french fries goya chanpuru kinpira-style sauteed burdock hot dog mixed rice burger sauteed spinach sweet and sour pork egg soy-side up fried shrimp

FoodRec: foodrec app with UECFOOD100 by Hamlyn Centre-Imperial College (UK)



The screenshot shows the Google Play Store interface for the FoodRec app. At the top, the Google Play logo is on the left, and a search bar with the Japanese text "検索" (Search) is in the center. On the right, the user's name "Keiji" and a grid icon are visible. Below the search bar, there are navigation options: "カテゴリ" (Category), "ホーム" (Home), "トップチャート" (Top Charts), and "新作" (New). A sidebar on the left lists "マイアプリ" (My Apps), "ショップ" (Shop), "ゲーム" (Games), "ファミリー" (Family), "保護者向けのガイド" (Parental Guide), and "エディターのおすすめ" (Editor's Picks). The main content area features the app's title "FoodRec", the developer "Hamlyn Centre-Imperial College - 2015年3月13日 - レーティングなし 医療" (Hamlyn Centre-Imperial College - March 13, 2015 - No Rating Medical), and a green "インストール済み" (Installed) button. Below this, a note states "このアプリはお使いの一部の端末に対応しています。" (This app is compatible with some of your devices). The app has a rating of 3 stars from 3 users and a "Google おすすめ" (Google Recommended) badge.

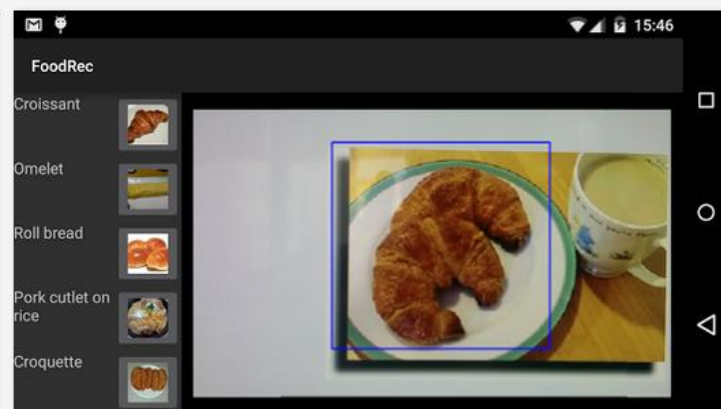
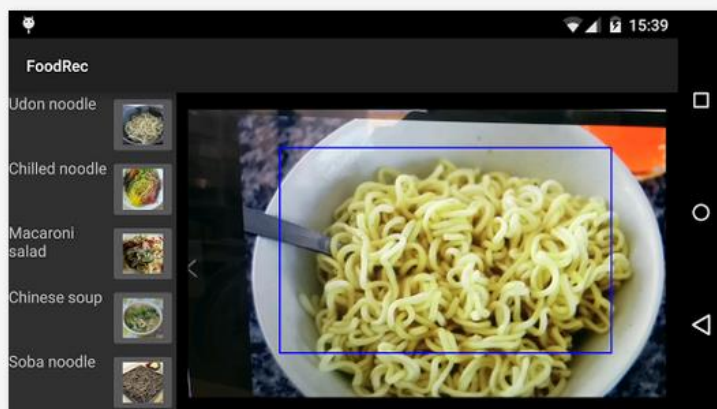

UEC-FOOD as a Fine-Grained Image Classification Dataset

arXiv.org > cs > arXiv:1502.07802

Search or Article-id

Computer Science > Computer Vision and Pattern Recognition





















































































































































Modelling Local Deep Convolutional Neural Network Features to Improve Fine-Grained Image Classification

ZongYuan Ge, Chris McCool, Conrad Sanderson, Peter Corke

(Submitted on 27 Feb 2015)

We propose a local modelling approach using deep convolutional neural networks (CNNs) for fine-grained image classification. Recently, deep CNNs trained from large datasets have considerably improved the performance of object recognition. However, to date there has been limited work using these deep CNNs as local feature extractors. This partly stems from CNNs having internal representations which are high dimensional, thereby making such representations difficult to model using stochastic models. To overcome this issue, we propose to reduce the dimensionality of one of the internal fully connected layers, in conjunction with layer-restricted retraining to avoid retraining the entire network. The distribution of low-dimensional features obtained from the modified layer is then modelled using a Gaussian mixture model. Comparative experiments show that considerable performance improvements can be achieved on the challenging Fish and UEC FOOD-100 datasets.

UEC-FOOD 256

																	
loco moco	adobo	lumpia	apple pie	brownie	meat loaf	malasada	マンゴープリン (mango pudding)	雑煮 (zoni)	お吸い物 (clear soup)	もずく (mozuku)	ヒレカツ (pork fillet cutlet)	メンチカツ (minced mear cutlet)	沖縄そば (okinawa soba)	羊肉串 (lamb kebabs)	烤鸭 (roast duck)	月餅 (moon cake)	
																	
排骨飯 (pork cutlet)	臭豆腐 (stinky tofu)	炒面 (chow mein)	椒盐虾 (salt & pepper fried shrimp with shell)	ส้มตำ (Thai papaya salad)	อาหารไก่ (spicy chicken salad)	อาหารก๋วยเตี๋ยว (Pork Sticky Noodles)	ผัดต้มยำ (hot and sour, fish and vegetable ragout)	ไก่ผัดน้ำ (boned, sliced Hainan-style chicken with marinated)	หมูสะตือ (pork satay)	ข้าวซอย (khao soi)	ayam goreng	bubur ayam	laksa	mie ayam	ayam bakar	nasi uduk	
																	
babi guling	pancake	popcorn	churro	jambalaya	釜飯 (kamameshi)	串カツ (kushikatu)	ちゃんぽん (champon)	お粥 (rice gruel)	ロースカツ ((pork loin cutlet))	チキンカツ ((chicken cutlet))	馬刺し (thinly sliced raw horsemeat)	おしるこ (oshiruko)	杏仁 (almond j Ely)	回鍋肉 (twice cooked pork)	锅包肉 (fried pork in scoop)	地三鮮 (dish Consisting of stir-fried potato, eggplant and green pepper)	
																	
小籠包 (xiao l ong bao)	蛋撻 (custard tart)	牛肉麵 (beef Noodle soup)	魚丸湯 (fish ball soup)	蚵仔煎 (oyster Omelette)	炸醬面 (zha jiang mian)	宮保鸡丁 (kung pao chicken)	鱼香茄子 (eggplant with garlic sauce)	红烧狮子头 (braised pork meat ball with napa cabbage)	冬瓜汤 (winter melon soup)	蒸排骨 (steamed Spareribs)	南瓜饼 (chinese pumpkin pie)	八宝饭 (eight treasure rice)	酸辣汤 (hot & sour soup)	ส้มตำกุ้ง (Sour prawn soup)	เนื้อเค็มกับน้ำจิ้ม (beef in oyster sauce)	หมูกรอบ (Pork with lemon)	
																	
สามขา (stewed pork leg)	คอหมูย่าง (charcoal-boiled pork neck)	ปีกไก่ทอด (deep fried chicken wing)	ข้าวหมูแดง (barbecued red pork in sauce with rice)	ข้าวหมูขาว (rice with roast duck)	ข้าวหมูกรอบ (rice crispy pork)	วุ้นเส้น (wonton Soup)	เส้นก๋วยเตี๋ยว (crispy Noodles)	ข้าวต้ม (egg noodle In chicken yellow curry)	ส้มตำ (coconut milk soup)	gulai	mie goreng	nasi campur	Phở (pho)	Bún bò Huế (hue beef rice vermicelli soup)	Bánh cuốn (steamed rice roll)	Bánh xèo (coconut milk-flavored crepes with shrimp and beef)	
																	
three cup chicken (三杯鸡)	Chè trôi nước (glutinous rice balls)	찌개 (jjjgae)	나물 (samul)	paella	tiramisu (tiramisu)	waffle	shortcake	french toast	minestrone	pot au feu	bagel	scone	nachos	rice gratin	muffin	crullers (油条)	
																	
green curry	dak galbi	dry curry	rice vermicelli	tanmen (汤面)	yellow curry	crape	rare cheese cake	chop suery	masurrom risotto	fine white noodles	chicken nugget	namero	french bread	broiled eel bowl	yudofu	inarizushi	baked salmon (烤三文鱼)
																	
ham cutlet	tortilla	tacos	scrambled egg	lasagna	caesar salad	oatmeal	fried pork dumplings served in soup (水餃)	cream puff	doughnut	parfait	hot pot (火锅)	Pork belly (東坡肉)	minced pork rice (魯肉飯)	glutinous oil rice	trunip Pudding (蘿蔔糕)	lemon fig jelly (愛玉)	Small steamed Savory rice pancake
																	
mixed vegetables (蒜蓉炒时蔬)	noodles with fish curry (ผัดผักรวมมิตร)	fried mussel Pancakes (หอยทอด)	Chicken rice Curry with Coconut (ข้าวไก่ทอด)	vermicelli noodles with snails (Bún ốc)	fried spring rolls (Nem rán)	shrimp patties (Bánh tôm)	ball shaped Bun with pork (Bánh bao)	haupia	laulau	spam musubi	oxtail soup	nasi goreng	nasi padang	kaya toast	bak kut teh	curry puff	been curd family style (家常豆腐)

UEC-FOOD 256



loco moco adobo lumpia apple pie brownie meat loaf malasada マンゴープリン (mango pudding) 雑煮 (zoni) お吸い物 (clear soup) もずく (mozuku) ヒレカツ (pork fillet cutlet) メンチカツ (minced mear cutlet) 沖縄そば (okinawa soba) 羊肉串 (lamb kebabs) 烤鸭 (roast duck) 月餅 (moon cake)



排骨飯 (pork cutlet) 臭豆腐 (stinky tofu) 炒面 (chow mein) 椒盐虾 (salt & pepper fried shrimp with shell) 木瓜沙 (Thai papaya salad) 鸡肉沙拉 (spicy chicken salad) 猪肉炒粉 (Pork Sticky Noodles) 酸辣汤 (hot and sour, fish and vegetable with marinated) 海南鸡 (sliced Hainan-style chicken) 猪肉串 (pork satay) 猪肉排 (pork loin cutlet) 冬瓜汤 (winter melon soup) 椰奶汤 (coconut milk soup) 杂菜汤 (minestrone)



green curry dak galbi dry curry rice vermicelli tanmen (汤面) yellow curry crape rare cheese cake chop suery masurrom risotto fine white noodles chicken nugget namero french bread broiled eel bowl yudofu inarizushi baked salmon (三文鱼)



ham cutlet tortilla tacos scrambled egg lasagna caesar salad oatmeal 猪肉水餃 (fried pork dumplings served in soup) cream puff doughnut parfait 火锅 (hot pot) 东坡肉 (Pork belly) 鲁肉饭 (minced pork rice) 糯米油饭 (glutinous oil rice) 萝卜糕 (trunip Pudding) 爱玉 (lemon fig jelly) 小蒸饺 (Small steamed Savory rice pancake)



mixed vegetables (杂菜) 鱼咖喱粉 (noodles with fish curry) 炸蚶蚶 (fried mussel Pancakes) 椰菜饭 (Chicken rice Curry with Coconut) 螺肉粉 (vermicelli noodles with snails) 炸春卷 (fried spring rolls) 虾饼 (shrimp patties) 猪肉包 (ball shaped Bun with pork) 哈皮 (haupia) 捞肉 (laulau) Spam (spam musubi) 猪尾汤 (oxtail soup) 炸饭 (nasi goreng) 椰菜饭 (nasi padang) 椰菜吐司 (kaya toast) 排骨汤 (bak kut teh) 咖喱包 (curry puff)

baked salmon (三文鱼)
Small steamed Savory rice pancake
been curd family style (家常豆腐)

UEC-FOOD 256



loco moco adobo lumpia apple pie brownie meat loaf malasada マンゴープリン (mango pudding) 雑煮 (zoni) お吸い物 (clear soup) もずく (mozuku) ヒレカツ (pork fillet cutlet) メンチカツ (minced mear cutlet) 沖縄そば (okinawa soba) 羊肉串 (lamb kebabs) 烤鸭 (roast duck) 月餅 (moon cake)



排骨飯 (pork cutlet) 臭豆腐 (stinky tofu) 炒面 (chow mein) 椒盐虾 (salt & pepper fried shrimp with shell) 青木瓜 (Thai papaya salad) 辣子鸡 (spicy chicken salad) 猪肉粉条 (Pork Sticky Noodles) 酸辣汤 (hot and sour, fish and vegetable ragout) 海南鸡饭 (sliced Hainan-style chicken with marinated) 猪肉串 (pork satay) 咖喱粉 (khao soi) ayam goreng bubur ayam laksa mie ayam ayam bakar nasi uduk



babi gu 小籠包 (xiao long bao) 猪肉炖粉条 (stewed pork le) 三杯鸡 (three cup chicken) 青咖喱 (green curry) dak galbi dry curry 米线 (rice vermicelli) 担担面 (tanmen) 黄咖喱 (yellow curry) 可丽饼 (crape) 芝士蛋糕 (rare cheese cake) 炸春卷 (chop suery) 肉末炒米粉 (masurrom risotto) 细粉 (fine white noodles) 炸鸡块 (chicken nugget) 纳豆 (namero) 法式面包 (french bread) 烤鱼 (broiled eel bowl) 豆腐 (yudofu) 天妇罗 (inarizushi) 烤三文鱼 (baked salmon)



ham cutlet tortilla tacos scrambled egg lasagna caesar salad oatmeal 猪肉水饺 (fried pork dumplings served in soup) cream puff doughnut parfait hot pot (火锅) 东坡肉 (Pork belly) 鲁肉饭 (minced pork rice) 糯米油饭 (glutinous oil rice) 芋圆 (trunip Pudding) 爱玉 (lemon fig jelly) 小笼包 (Small steamed Savory rice pancake)



mixed vegetables 鱼咖喱粉 (noodles with fish curry) 炸蚶蚶 (fried mussel Pancakes) 椰菜饭 (Chicken rice Curry with Coconut) 蚶蚶粉 (vermicelli noodles with snails) 炸春卷 (fried spring rolls) 炸春卷 (shrimp patties) 炸春卷 (ball shaped Bun with pork) haupia laulau spam musubi oxtail soup nasi goreng nasi padang kaya toast bak kut teh curry puff



green curry dak galbi dry curry 米线 (rice vermicelli) 担担面 (tanmen) 黄咖喱 (yellow curry) 可丽饼 (crape) 芝士蛋糕 (rare cheese cake) 炸春卷 (chop suery) 肉末炒米粉 (masurrom risotto) 细粉 (fine white noodles) 炸鸡块 (chicken nugget) 纳豆 (namero) 法式面包 (french bread) 烤鱼 (broiled eel bowl) 豆腐 (yudofu) 天妇罗 (inarizushi) 烤三文鱼 (baked salmon)

fish of potato, and per
with
ed
d beef
ers
(

UEC-FOOD 256



yanmieonline.com



ETH-Food101

- **Sushi**



- **Takoyaki**



- **Ramen**



Baseline features & classifiers

- **Conventional baseline features**
 - Root HOG patch and Color patch
 - Fisher Vector (FV)
 - SPM level2 (1x1+3x1+2x2)
 - 32768-dim RootHOG-FV
 - 24576-dim Color-FV
- **Classifiers**
 - 1-vs-rest multiclass linear SVM
- **Evaluation: 5fold cross-validation**

Results: UEC-FOOD100

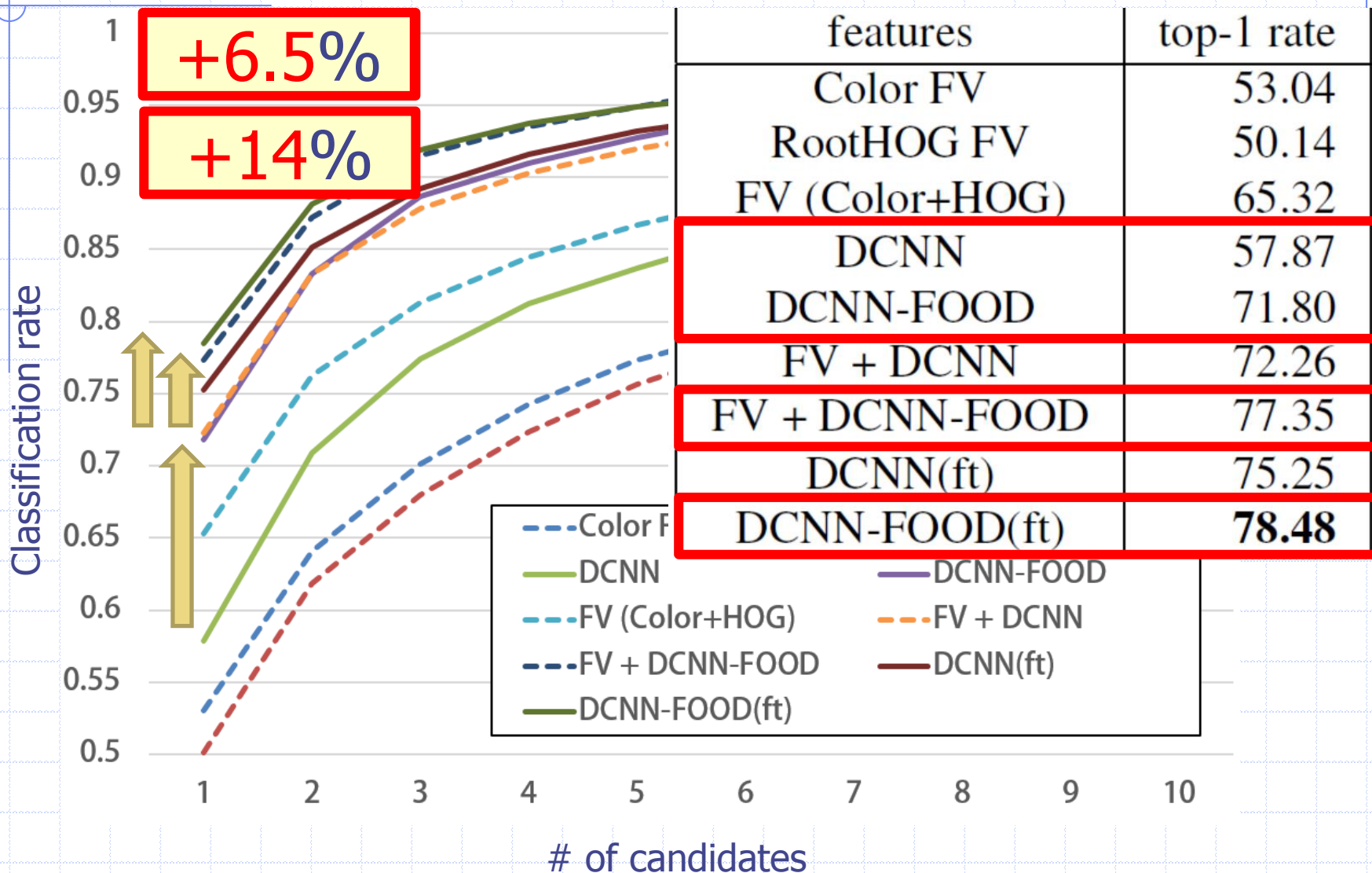

Results: UEC-FOOD256

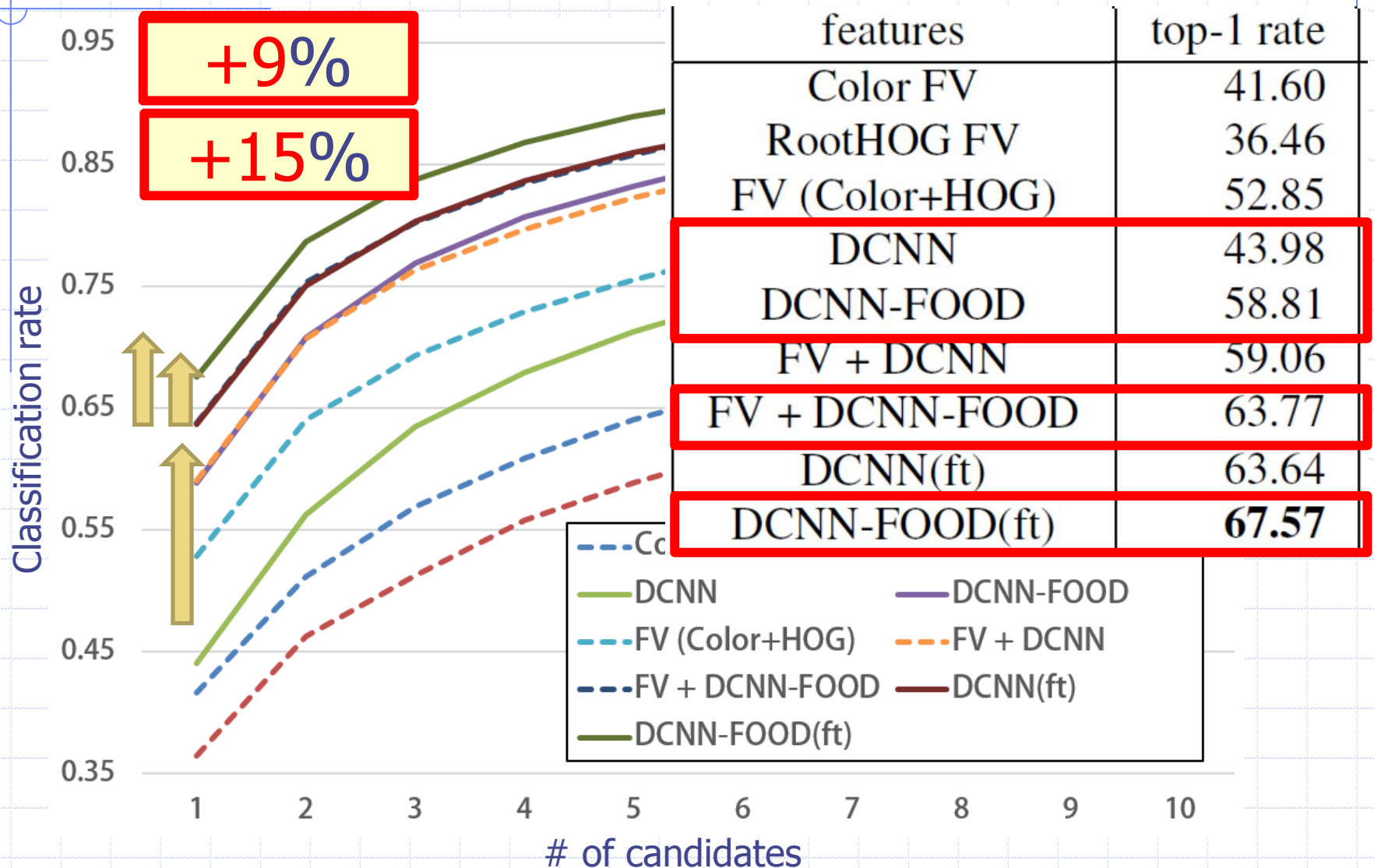

Results on ETH-Food101

Table 2. Classification rate on ETH Food-101 dataset [1].

RF-based [1]	DCNN [1]	DCNN(ft)	FOOD-DCNN(ft)
50.76	56.40	68.44	70.41

- **Fine-tuned DCNN with ImageNet+food1000 pretraining achieved the best results.**

Summary

- **Pre-training with ImageNet + Food1000 is effective.**
- **Fine-tuning can improve performance over Pre-training DCNN + FV.**
- **Fine-tuning the DCNN which was pre-trained with ImageNet1000 + Food1000 is the best.**

Comments:

- **For further improvements**
 - Using deeper network (VGG16 or GoogLeNet) instead of Alexnet
 - Fusing DCNN-FOOD (ft) with FV
- **Both are not examined yet.**
 - (Because the second author graduated...)

Apply DCNN-FOOD(ft) to Twitter Real-time Food Photo Mining

Keiji Yanai and Yoshiyuki Kawano: Twitter Food Image Mining and Analysis for One Hundred Kinds of Foods , Pacifit-Rim Conference on Multimedia (PCM), (2014).

Yoshiyuki Kawano and Keiji Yanai, **FoodCam: A Real-time Food Recognition System on a Smartphone**, Multimedia Tools and Applications (2014). (in press) (<http://dx.doi.org/10.1007/s11042-014-2000-8>)

Objective

- **Twitter Photo Mining for Food Photos**
 - As a case study of Twitter Photo Mining on specific kinds of photos
 - **Food is one of frequent topics of Twitter Photos.**
 - Real-time Photo Collection from the stream
- **To collect more food photos for training**
 - Twitter is a good source of food photos.
 - Unlike “FoodLog”, we have no users who upload their food photos regularly. Twitter is alternative.

Preparation

- Add “non-food” category to the best classifier (FOOD-DCNN (ft)).
- Prepare 10000 non-food samples gathered from Twitter by 100 food names
- Fine-tuning with 101 category.



- Food/non-food classification: 98.86%

Approach for food photo mining

- [old] Three-step food photo selection



- [new] Two-step food photo selection

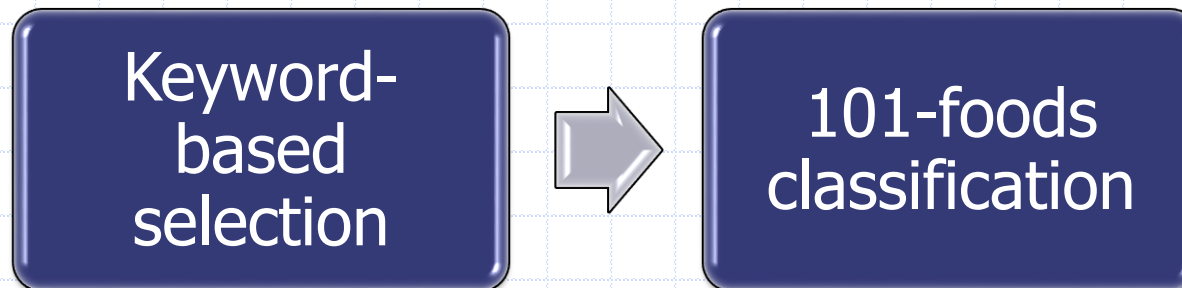

Experiments

- **Collect photo tweets via Twitter Streaming API**
 - From 2011/5 to 2013/8
 - About one billion tweets
- **Search for the tweets including any of 100-food names (in Japanese)**
 - 1.7 million \Leftarrow Apply food image classifier
 - 0.03 image/classification w/GPU
(4 hours by 4 GPU machines)

Twitter food photo ranking

rank	foods		#photos
			
			
			
			
			

Ramen noodle is the most popular food in Japan.
I have solved “ramen vs curry” problem !!!

Precision of the top 5 foods

Food	raw	FV-based	DCNN
ramen	275,652 72.0%	80,021 99.7%	132,095 99.5%
curry	224,685 75.0%	59,264 99.3%	68,091 100.0%
sushi	86,509 69.0%	25,898 92.7%	224,908 99.8%
tsukem en	33,165 88.7%	22,158 99.0%	22,004 100.0%
omelet	34,125 90.0%	17,520 99.0%	20,039 99.9%

Only keyword search (Ramen noodle) (72.0%)



After applying 100-class food classifier (final) (99.5%)



Only keyword search (curry) (75.0%)



Final results (curry) (100%)

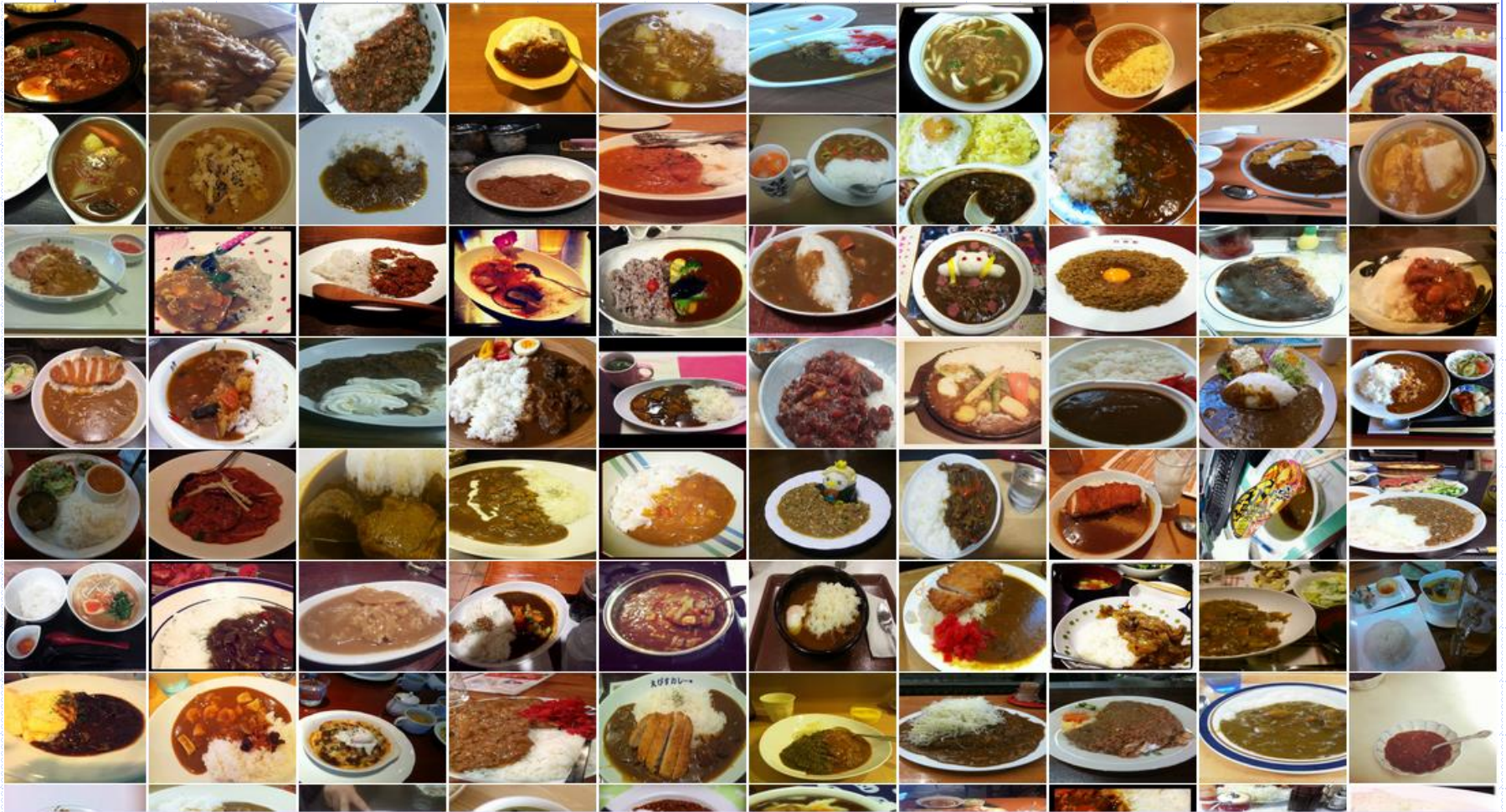

Final results (omelet) (99.9%)

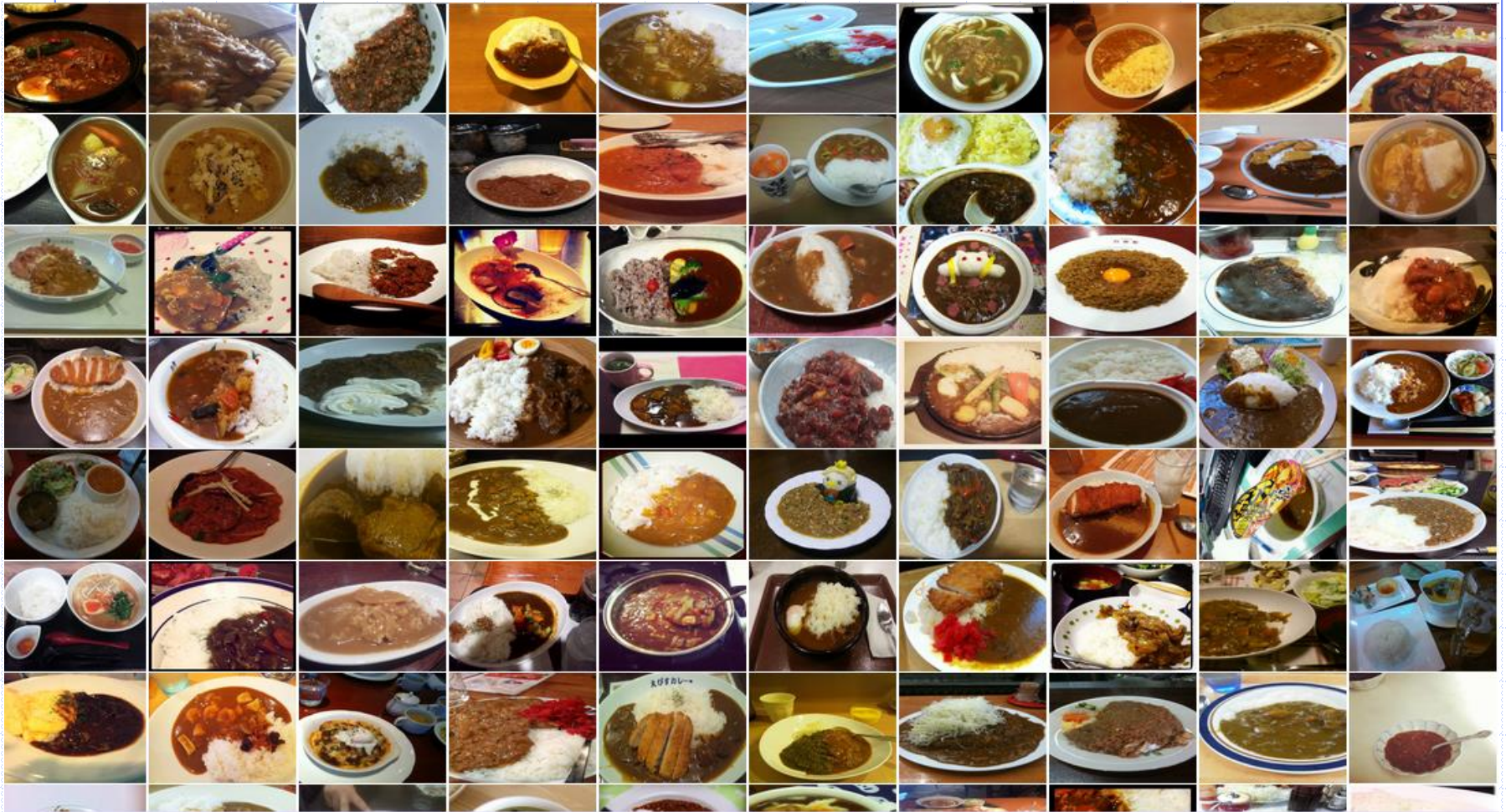

Misclassified photos

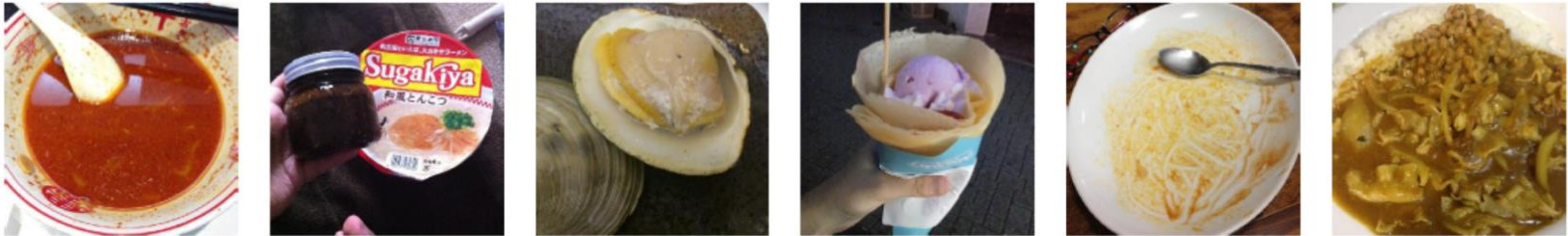
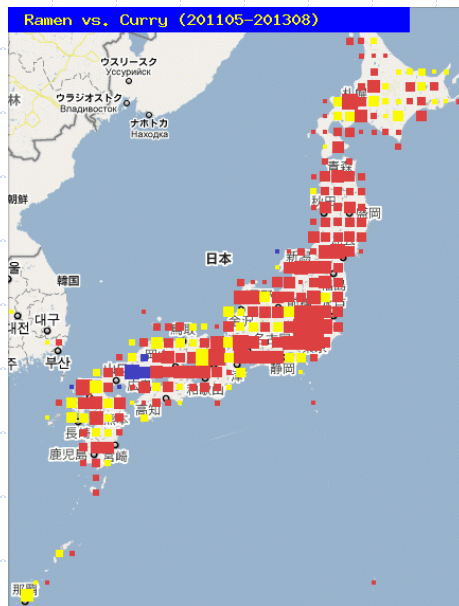

Fig. 6. Examples of misclassified Twitter food photos. Eaten ramen bowl (recognized as “ramen”), unopened instant ramen (ramen), a clam (sushi), ice cream (sushi), an eaten plate (omelet) and curry without cutlet (cutlet curry).

Geographical-Temporal analysis on **ramen vs curry**

12.6% of the obtained food photos have geotag.



Whole year



Dec. (winter)

Ramen is popular.

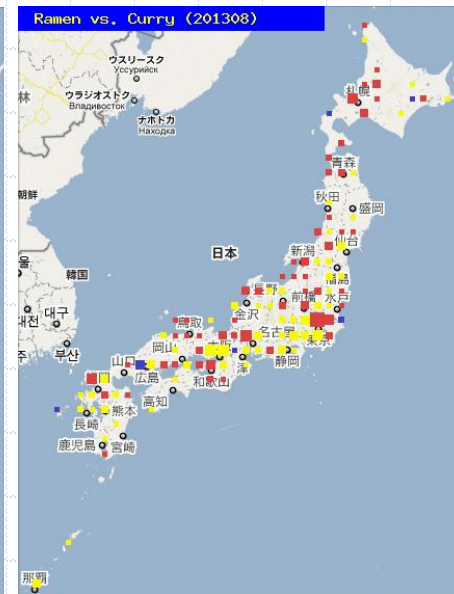

Aug. (summer)

Curry gets more popular
than ramen in many areas.

● **Ramen**

● **Curry**

Utilization of large number of food photos: Omerice analysis

- Omerice-style classification
 - Classification rate: 84.184%



(途中結果200枚) (途中結果1000枚)

letters



(途中結果200枚) (途中結果1000枚)

drawing



(途中結果200枚) (途中結果1000枚)

texture



(途中結果200枚) (途中結果1000枚)

source



(途中結果200枚) (途中結果1000枚)

plain

認識結果：

各1000枚で学習. 1500枚を分類

分類先⇒	文字	絵	模様	ソース	プレーン
文字	85.6	10.0	3.1	1.1	0.1
絵	9.9	84.2	3.5	1.9	0.5
模様	3.1	5.7	80.7	8.8	1.6
ソース	1.2	1.9	6.9	86.5	3.5
プレーン	0.0	2.9	0.0	15.8	81.3

Real-time Food Collection

- Monitor the Twitter stream
 - Photo Tweet
 - Text including any of 100 food names
 - 13 candidate photo tweets / minute on avg.
 - Download: 2~3sec. , recognition: ~1sec.
 - Single machine is enough !
- Recognize 20,000 photos and find 5,000 food photos from the TW stream everyday in our lab

Demo visualization system

- Map each food photo on an online map with online clustering [Yanai ICMR2012]
 - Geotagged Tweets
 - Non-geotagged Tweets for which GeoNLP can assign locations based on text msg.
- Overlay a food photo on the Streetview
 - Finding “ramen noodle shop” game !

<http://mm.cs.uec.ac.jp/tw/>

Twitter Food Image Bots

- Bot who recognize food photos and return results
 - @foodimg_bot
- Bot who re-tweets food photo tweets automatically



DeepFoodCam



Release soon
at <http://foodcam.mobi/>

- DCNN-based food rec. app
 - Network-in-network (NIN) instead of AlexNet
 - PQ-based weight compression (7MB \Leftrightarrow 256MB)



Conclusions

- **Food recognition with DCNN features**
 - Pre-trained DCNN with ImageNet2000 categories
 - Fine-tuned the pre-trained DCNN with UEC-FOOD
- **Achieved the best performance so far**
 - UEC FOOD-100: 78.48%
 - UEC FOOD-256: 94.85%
- **We showed the effectiveness for the application, Twitter food photo mining**

Future works

- CNN-based food region segmentation

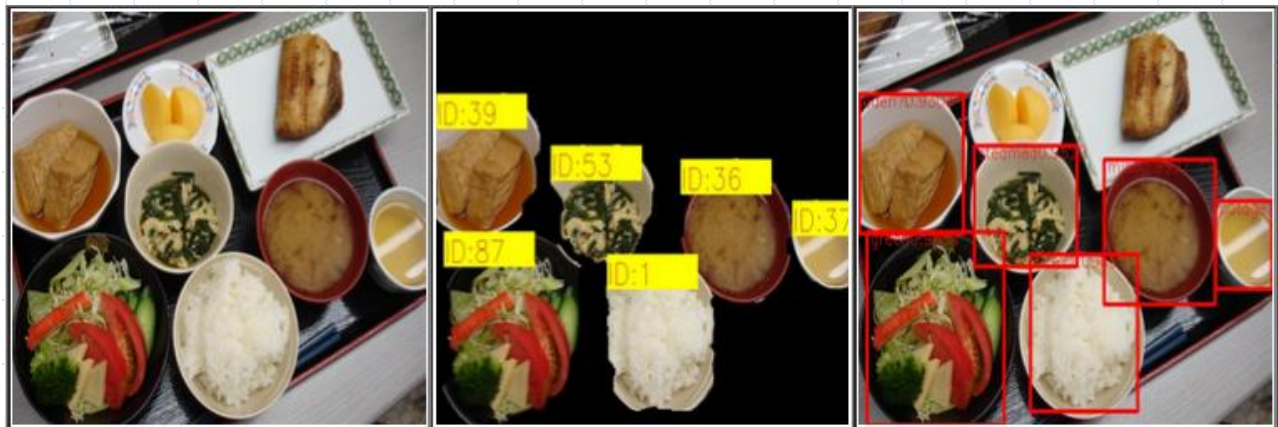
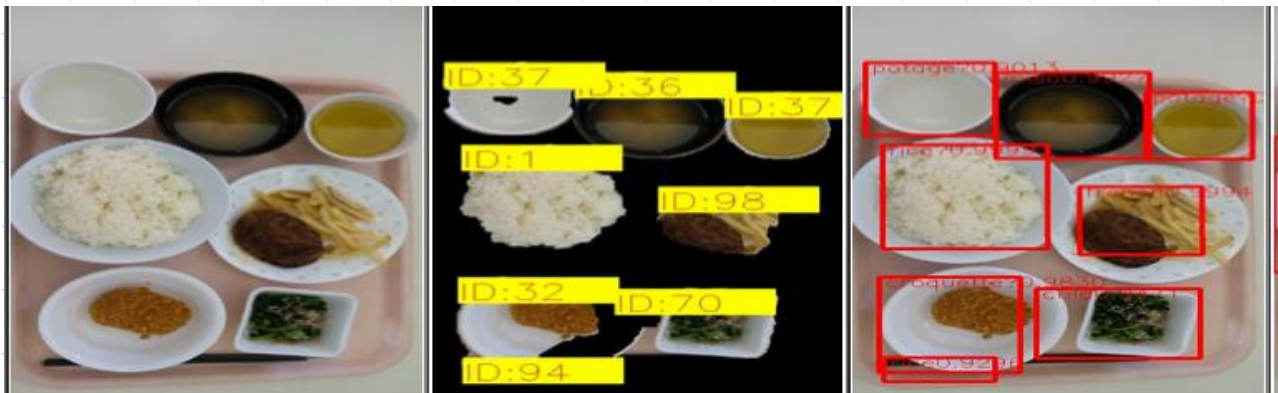

Thank you for your attention !

Real-time Geo-Tweet Food Photo Mapping System

豊島区, 東京都
近辺

RT @byassist: 昭和歌謡ショー@庚申塚の中華そば。煮干し出汁に慣れた舌には物足りなくもあるが、これはこれで昔から馴染みの正統派無化調の醤油ラーメン。素直に美味しい♪ [nlp #sg]

Google
豊島区, 東京都 Mon Dec 01 12:59:47 2014 JST

韓国 豊島区, 東京都 和歌山 高松 高知 大分 松山



1	ramen noodle	80021
2	curry	59264
3	sushi	25898
4	dipping noodle	22158
5	omelet with fried rice	17520
6	pizza	16921
7	jiaozi	16014
8	Japanese-style pancake	15234
9	steamed rice	14264
10	sashimi	13927
11	hambarg steak	11583
12	beef stake	9503
13	takoyaki	9004
14	fried rice	8383
15	fried noodle	7905
16	oden	7453
17	toast	6350
18	cutlet curry	6339
19	tempura	5905
20	rice ball	5462
21	gratin	5223
22	croquette	4837
23	stew	4797
24	sashimi bowl	4730
25	chicken-'n'-egg on rice	4513
26	tempura bowl	4464
27	beef bowl	4285
28	spicy chili-flavored tofu	4081
29	yakitori	3829
30	hamburger	3662
31	chilled noodle	3473
32	sukiyaki	3408
33	miso soup	3295



34	fish-shaped pancake with bean jam	3281
35	pork cutlet on rice	3188
36	omelet with grilled minced meat	2592
37	bibimbap	2368
38	spaghetti	2171
39	lightly roasted fish	2162
40	seasoned beef with potatoes	2129
41	natto	2094
42	spaghetti with meat source	1994
43	steamed egg hotchpotch	1843
44	egg sunny-side up	1635
45	croissant	1579
46	udon noodle	1500
47	simmered pork	1443
48	mixed sushi	1371
49	pork miso soup	1229
50	ginger-fried pork	1158
51	potato salad	1150
52	egg omelet	1146
53	eels on rice	1071
54	egg roll	1058
55	sweet and sour pork	1049
56	fried shrimp	1049
57	sauteed vegetables	1040
58	shrimp with chill source	1003
59	cabbage roll	965
60	mixed rice	901
61	pilaf	891
62	soba noodle	880
63	potage	816
64	hot dog	795
65	chicken rice	736
66	wiener sausage	577

67	dried fish	563
68	steamed meat dumpling	561
69	french fries	561
70	beef ramen noodle	555
71	sandwiches	551
72	cold tofu	517
73	boiled chicken and vegetables	352
74	sirloin cutlet	331
75	nanbanzuke	323
76	fried chicken	314
77	stir-fried beef and peppers	312
78	roll bread	288
79	roast chicken	263
80	macaroni salad	239
81	boiled fish	228
82	kinpira-style sauteed burdock	225
83	tempura udon	213
84	raisins bread	205
85	goya chanpuru	198
86	green salad	145
87	chinese soup	141
88	Japanese tofu and vegetable chowder	137
89	salmon meuniere	96
90	grilled pacific saury	84
91	chip butty	76
92	fried fish	72
93	begitable tempura	71
94	tensin noodle	69
95	ganmodoki	34
96	grilled salmon	25
97	sauteed spinach	12
98	teriyaki grilled fish	3
99	grilled eggplant	2
100	pizza toast	0



2.1 group and some food categories

noodles	udon noodles, dipping noodles, ramen
yellow color	omlet, potage, steamed egg hotchpotch
soup	miso soup, pork miso soup, japanese tofu and vegetable chowder
fried	takoyaki, japanese-style pancake, fried noodle
deep fried	croquette, sirloin cutlet, fried chicken
salad	green salad, sauteed vegetables, vegetable tempura
bread	sandwiches, raisin bread, roll bread
seafood	sashimi, sashimi bowl, sushi
rice	rice, pilaf, fried rice
fish	grilled salmon, grilled pacific saury, dried fish
boiled and seasoned	seasoned beef with potatoes simmered ganmodoki seasoned beef with potatoes
sauteed	sauteed vegetables, goya chanpuru, kinpira-style sauteed burdock
sauce	stew, curry, stir-fried shrimp in chili sauce



2.1 group and some food categories

noodles	udon noodles, dipping noodles, ramen
yellow color	potato, potato, steamed egg hotpot
	
boiled and seasoned	seasoned beef with potatoes simmered ganmodoki seasoned beef with potatoes
sauteed	sauteed vegetables, goya chanpuru, kinpira-style sauteed burdock
sauce	stew, curry, stir-fried shrimp in chili sauce



2.1 group and some food categories

noodles	udon noodles, dipping noodles, ramen
yellow color	omlet, potage, steamed egg hotchpotch
	
ushi	
boiled and seasoned	grilled salmon, grilled pacific saury, dried fish seasoned beef with potatoes simmered ganmodoki seasoned beef with potatoes
sauteed	sauteed vegetables, goya chanpuru, kinpira-style sauteed burdock
sauce	stew, curry, stir-fried shrimp in chili sauce

2.1 group and some food categories

noodles	udon nooles, dipping noodles, ramen	
yellow color	omlet, potage, steamed egg hotchpotch	
soup	miso soup, pork miso soup, japanese tofu and vegetable chowder	
		
fish	grilled salmon, grilled pacific saury, dried fish	
boiled and seasoned	sesoned beef with potatoes simmered ganmodoki sesoned beef with potatoes	
sauteed	sauteed vegetables, goya chanpuru, kinpira-style sauteed burdock	
sauce	stew, curry, stir-fried shrimp in chili sauce	

2.1 group and some food categories

noodles	udon nooles, dipping noodles, ramen	
yellow color	omlet, potage, steamed egg hotchpotch	
		
boiled and seasoned	sesoned beef with potatoes simmered ganmodoki sesoned beef with potatoes	
sauteed	sauteed vegetables, goya chanpuru, kinpira-style sauteed burdock	
sauce	stew, curry, stir-fried shrimp in chili sauce	

【復習】

クラウドソーシング体験課題



文字 絵 模様 ソース

plain その他

clear



文字 絵 模様 ソース

plain その他

clear



文字 絵 模様 ソース

plain その他

clear



文字 絵 模様 ソース

plain その他

clear



文字 絵 模様 ソース

plain その他

clear



文字 絵 模様 ソース

plain その他

clear



文字 絵 模様 ソース

plain その他

clear



文字 絵 模様 ソース

plain その他

clear

オムライス種別分布

プレーン, 1816,

4%

文字, 8810, 18%

ソース, 20193,
41%

絵, 8135, 16%

模様, 10324,
21%

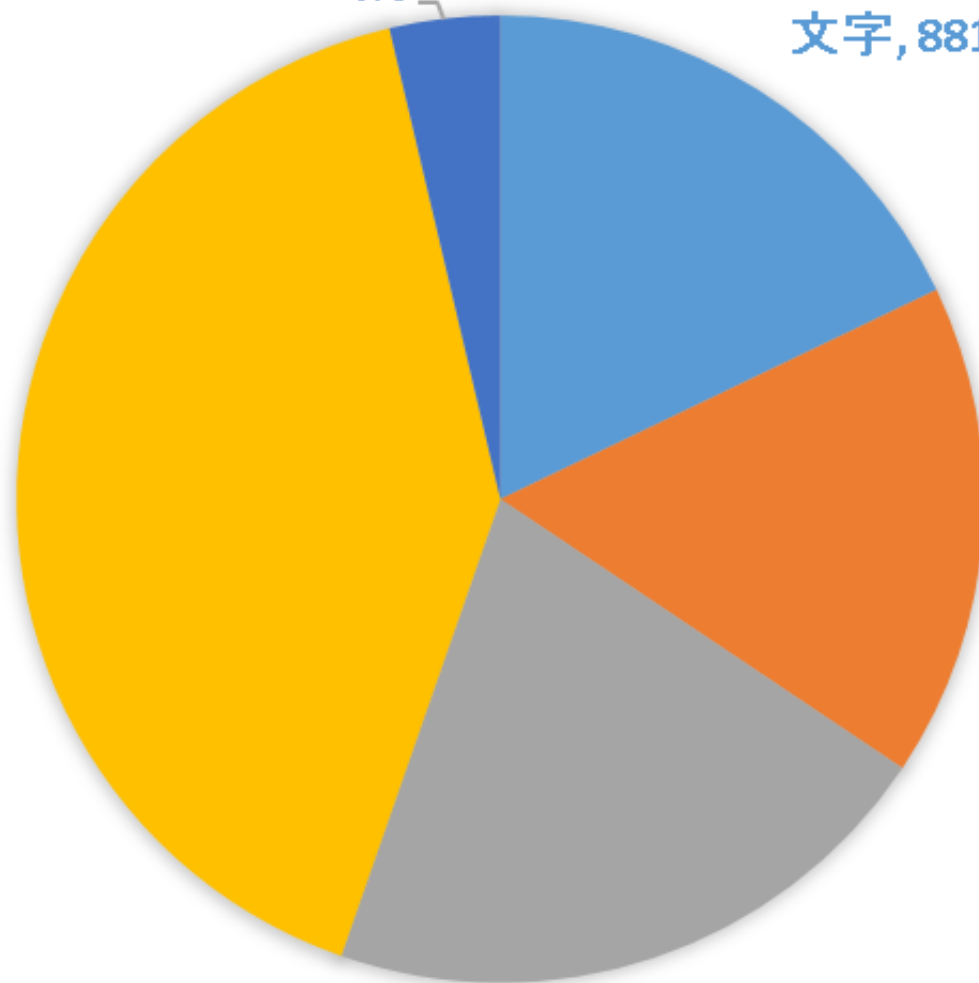

大規模画像認識のための 標準ネットワーク構成：Alex Net

- ILSVRC 2012 で, Alex Krizhevskyらが用いたネットワーク構成.
 - Alex Krizhevsky, I.Sutskever, J. Hinton : ImageNet Classification with Deep Convolutional Neural Networks, NIPS 2012.
- 2013, 2014はどのチームもこれをベースに改良, 拡張.
⇒ 事実上の標準ネットワーク.

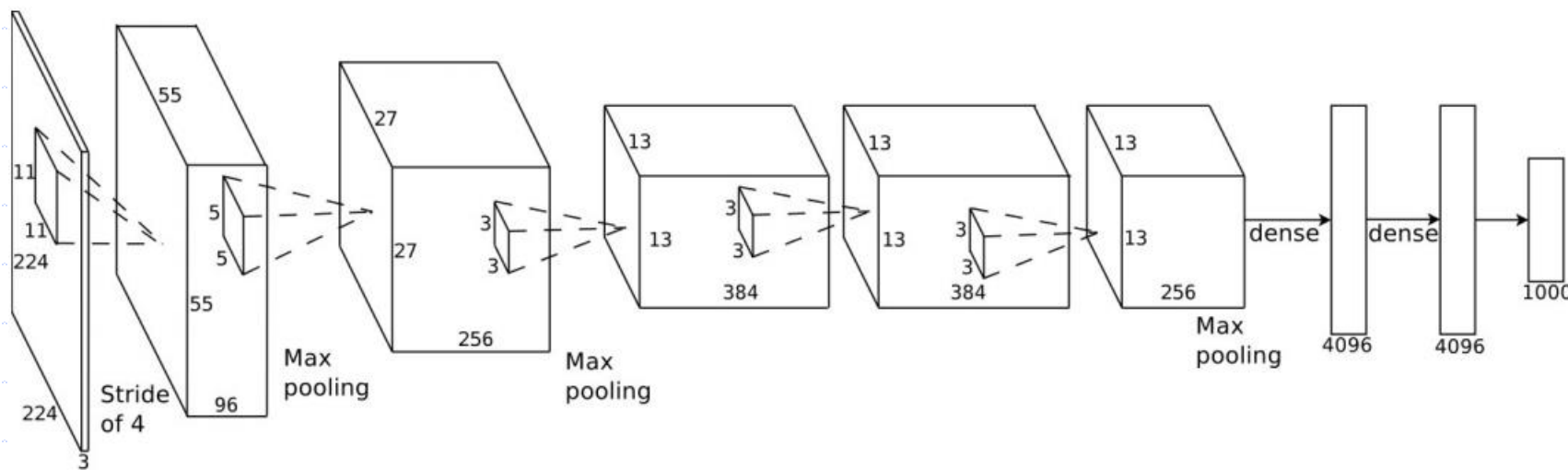

Convolutional network

- 前半が畳み込み層 (convolutional layer), 後半が昔と同じ全結合層 (full

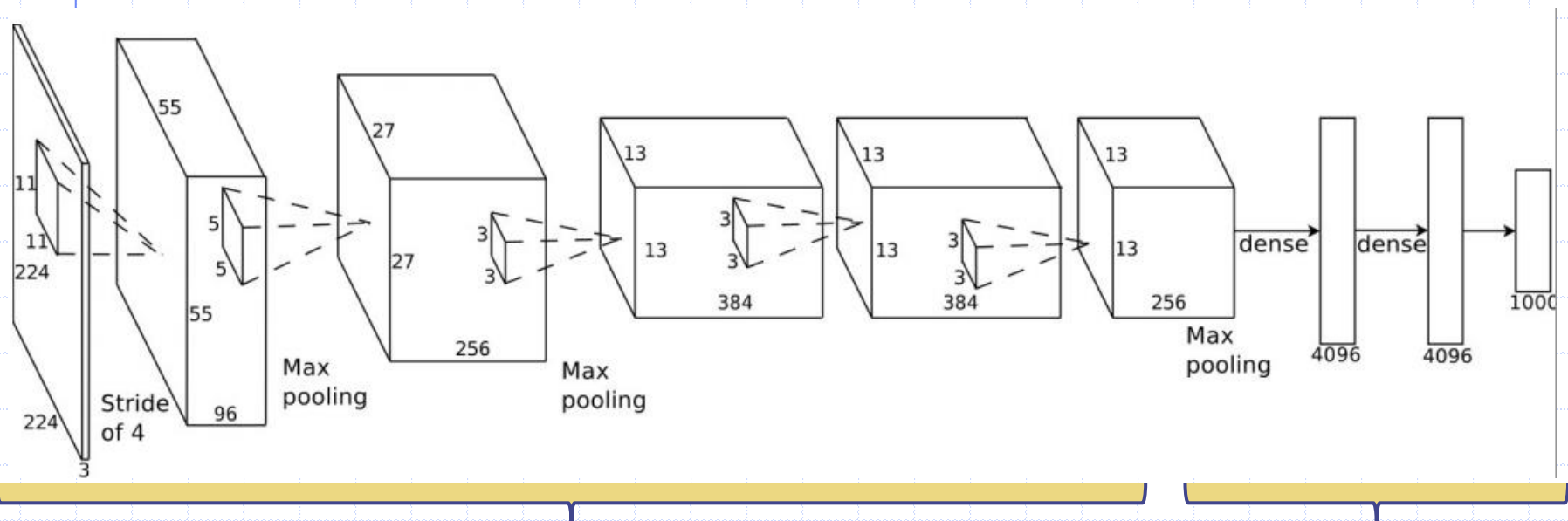

Convolutional layer

Full-connection layer